

## 1.3 MICRO CONNECTORS / MICRO D HARDWARE AND ACCESSORIES

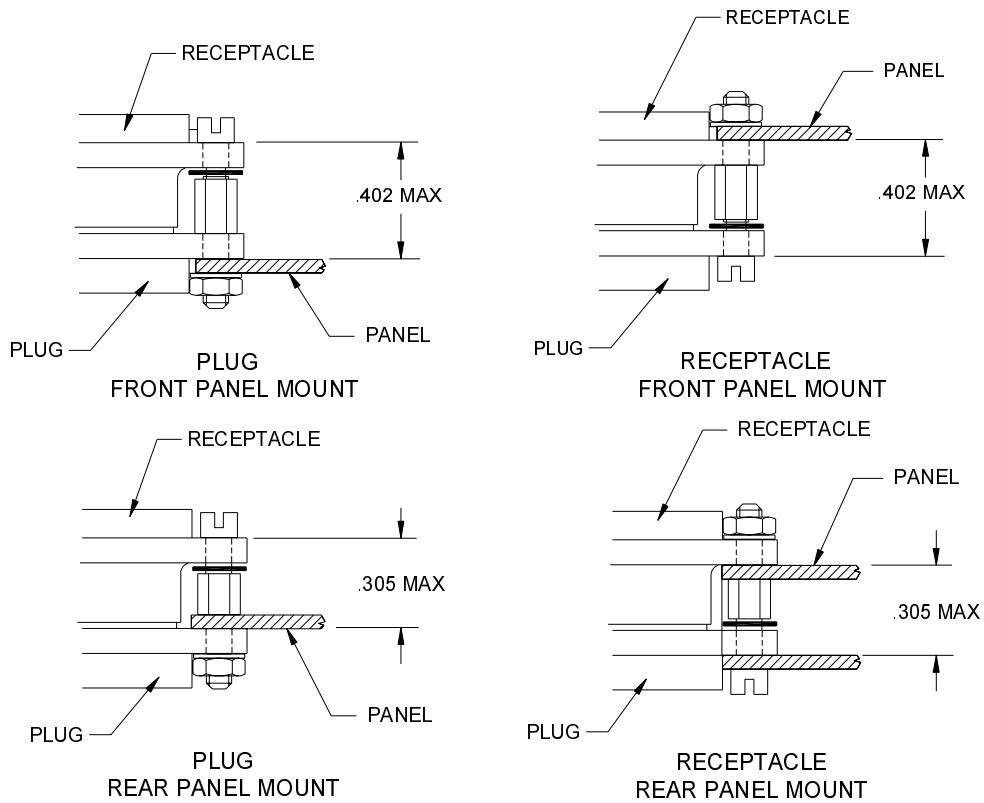

### MICRO-D SHELL PANEL MOUNTING EXAMPLES

SIZES 9-51  
REAR PANEL CUTOUT  
FOR PLUG & RECEPTACLE  
PLASTIC

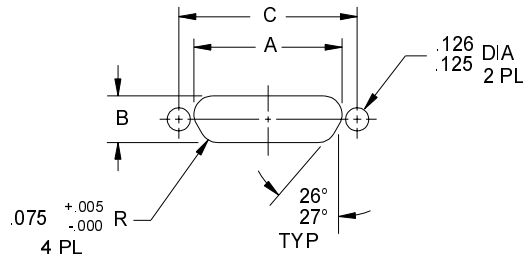

SIZE	A +.004 -.000	B +.004 -.000	C +.005 -.000
9	.379	.219	.565
15	.529	.219	.715
21	.679	.219	.865
25	.779	.219	.965
31	.929	.219	1.115
37	1.079	.219	1.265
51	1.029	.261	1.215

SIZES 9-51  
FRONT PANEL CUTOUT  
FOR PLUG & RECEPTACLE  
PLASTIC

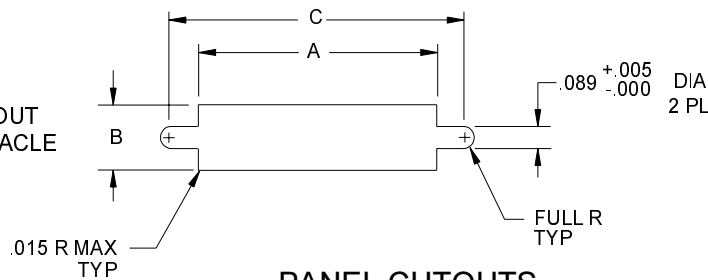

SIZE	A +.004 -.000	B +.004 -.000	C +.005 -.000
9	.409	.172	.565
15	.559	.172	.715
21	.709	.172	.865
25	.809	.172	.965
31	.959	.172	1.115
37	1.109	.172	1.265
51	1.059	.215	1.215

### PANEL CUTOUTS

CRISTEK INTERCONNECTS, INC.  
www.cristek.com  
1301 S. Lewis St.  
Anaheim, CA 92805  
Phone: (714) 618-2000  
FAX: (714) 535-4897

TITLE  
**MOUNTING APPROACHES  
FOR STYLES M83513, CMD & CPD**

FILENAME  
**ADS-MICRO-MTG-1**

DWG. NO.  
**MICRO MOUNTING**

CODE IDENT NO. <b>67720</b>	SHT <b>1</b> OF <b>2</b>	REV <b>G</b>
--------------------------------	--------------------------	-----------------

TOLERANCE: .XXX ±.005 .XX ±.01 ANGLE ±1°

SIZES 9-69  
REAR PANEL CUTOUT  
FOR PLUG & RECEPTACLE  
METAL

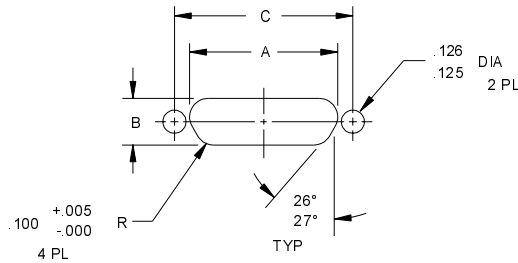

SIZE	A	B	C
	+ .004 - .000	+ .004 - .000	+ .005 - .000
9	.401	.252	.565
15	.551	.252	.715
21	.701	.252	.865
25	.801	.252	.965
31	.951	.252	1.115
37	1.101	.252	1.265
51	1.051	.295	1.215
69	1.351	.295	1.515

SIZE 9-69  
FRONT PANEL CUTOUT  
FOR PLUG & RECEPTACLE  
METAL

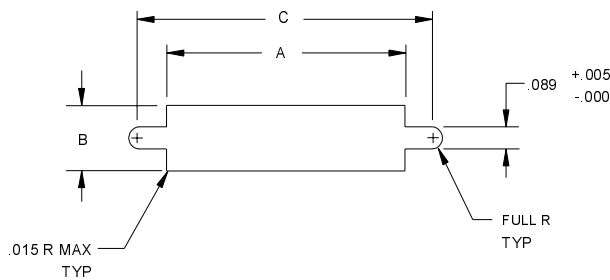

SIZE	A	B	C
	+ .004 - .000	+ .004 - .000	+ .005 - .000
9	.408	.271	.565
15	.558	.271	.715
21	.708	.271	.865
25	.808	.271	.965
31	.958	.271	1.115
37	1.108	.271	1.265
51	1.058	.315	1.215
69	1.358	.315	1.515

SIZE 100  
REAR PANEL CUTOUT  
FOR PLUG & RECEPTACLE  
METAL

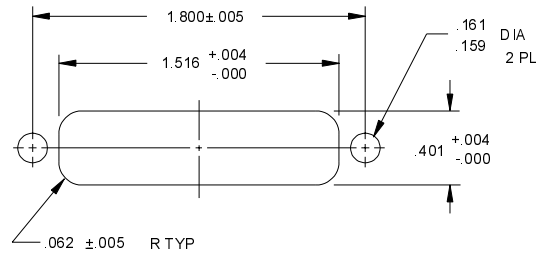

SIZE 100  
FRONT PANEL CUTOUT  
FOR PLUG & RECEPTACLE  
METAL

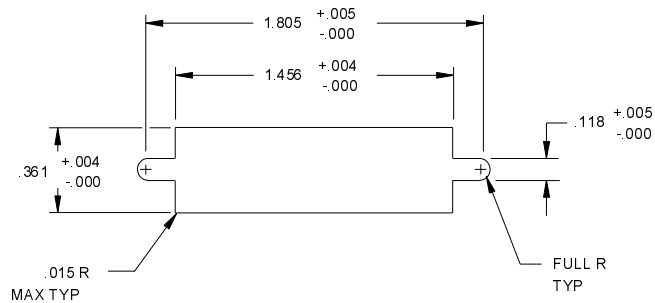

### PANEL CUTOUTS - CONT'D

CRISTEK INTERCONNECTS, INC. www.cristek.com 1301 S. Lewis St. Anaheim, CA 92805 Phone: (714) 618-2000 FAX: (714) 535-4897	TITLE	MOUNTING APPROACHES FOR STYLES M83513, CMD & CPD			DWG. NO.	MICRO MOUNTING		
	FILENAME	ADS-MICRO-MTG-2			CODE IDENT NO. 67720	SHT 2 OF 2	REV G	
					TOLERANCE: .XXX ± .005 .XX ± .01 ANGLE ± 1°			